



OWNER'S MANUAL

PORTABLE AIR CONDITIONER



MODEL 2AP10000A

TABLE OF CONTENTS

IMPORTANT:

Thank you for your purchase. Please read this manual carefully before operating.
Make sure to save this manual for future reference.

SAFETY INFORMATION	3
GROUNDING METHOD	6
ELECTRICAL CONNECTIONS	7
UNIT DESCRIPTION	8
INSTALLATION INSTRUCTIONS.....	9
OPERATION INSTRUCTIONS.....	13
REMOTE CONTROL	17
TIPS FOR USE	21
WATER DRAINAGE METHOD.....	22
CLEANING.....	24
TROUBLESHOOTING	25

- Disconnect the appliance from its power source during service and when replacing parts and cleaning.
- Check the rating label for the type of refrigerant gas used in your appliance.
- Do not pierce the cooling circuit of the machine. This hermetically sealed system contains fluorinated greenhouse gases.
- At the end of its useful life, deliver the appliance to a special waste collection center for disposal. GWP (Global Warming Potential): R410A: 2088, R134a: 1430, R290: 3, R32: 675.
- ENVIRONMENTAL INFORMATION: This unit contains fluorinated greenhouse gases covered by the Kyoto Protocol.
- Do not use this unit for functions other than those described in this instruction manual.
- Make sure the plug is plugged firmly and completely into the outlet. A loose connection can result in the risk of electric shock or fire.
- Do not plug other appliances into the same outlet, it can result in the risk of electric shock.
- Do not disassemble or modify the appliance or the power cord, it can result in the risk of electric shock or fire. All services should be referred to a qualified technician.
- Do not place the power cord or appliance near a heater, radiator, or other heat sources. It can result in the risk of electric shock or fire.
- This unit is equipped with a cord that has a grounded wire connected to a pin or grounding tab. The plug must be plugged into a socket that is properly installed and grounded. Do not under any circumstances cut or remove the pin or grounding tab from this plug.
- The unit should be used or stored in such a way that protects it from moisture (e.g. condensation, splashed water, etc.) Unplug the unit immediately if this occurs.
- Always transport your appliance in a vertical position and place it on a stable, level surface during use. If the unit is transported laying on its side it should be stood up and left unplugged for 6 hours.
- Always use the switch on the control panel or remote control to turn the unit off. Do not start or stop the operation by plugging in or unplugging the power cord. It can result in the risk of electric shock.
- Do not touch the buttons on the control panel with wet or damp fingers.
- Do not use hazardous chemicals to clean the unit. To prevent damage to the surface finish, use only a soft cloth to clean the appliance. Do not use wax, thinner, or a strong detergent. Do not use the unit in the presence of inflammable substance or vapor such as alcohol, insecticides, gasoline, etc.
- If the appliance is making unusual sounds or is emitting smoke or an unusual odor, unplug it immediately.
- Do not clean the unit with water. Water can enter the unit and damage the insulation, creating a shock hazard. If water enters the unit, unplug it immediately and contact Customer Service.
- For your safety, it is best to use two or more people to lift and install the unit.
- Always grasp the plug when plugging in or unplugging the appliance. Never unplug by pulling on the cord. It can result in the risk of electrical shock and damage.
- Install the appliance on a sturdy, level floor capable of supporting up to 110lbs(50kg). Installation on a weak or unlevel floor can result in the risk of property damage and personal injury.

- The appliance is compliant with the RE Directive (2014/53/EU).
- If the power cord is damaged it must be replaced by the manufacturer, its service agent, or similarly qualified person to avoid a hazard.
- The appliance should be installed in accordance with national wiring regulations.
- Minimum Installation Clearance: 17.5 inches around the unit and 17.5 inches above the unit.
- This appliance is not intended for use by persons (including children) with reduced physical, sensory or mental capabilities, or lack of experience and knowledge, unless they have been given supervision or instruction concerning use of the appliance by a person responsible for their safety.
- Children should be supervised to ensure that they do not play with the appliance.



CAN ICES-3 (B)/NMB-3(B)

FCC CAUTION

This device complies with part 15 of the FCC Rules. Operation is subject to the following two conditions: (1) This device may not cause harmful interference, and (2) this device must accept any interference received, including interference that may cause undesired operation. Any Changes or modifications not expressly approved by the party responsible for compliance could void the user's authority to operate the equipment.

Note: This equipment has been tested and found to comply with the limits for a Class B digital device, pursuant to part 15 of the FCC Rules. These limits are designed to provide reasonable protection against harmful interference in a residential installation. This equipment generates uses and can radiate radio frequency energy and, if not installed and used in accordance with the instructions, may cause harmful interference to radio communications. However, there is no guarantee that interference will not occur in a particular installation. If this equipment does cause harmful interference to radio or television reception, which can be determined by turning the equipment off and on, the user is encouraged to try to correct the interference by one or more of the following measures:

- Reorient or relocate the receiving antenna.
- Increase the separation between the equipment and receiver.
- Connect the equipment into an outlet on a circuit different from that to which the receiver is connected.
- Consult the dealer or an experienced radio/TV technician for help.

The following information is provided for appliances employing flammable refrigerants:

WARNING

- o Do not use means to accelerate the defrosting process or to clean, other than those recommended by the manufacturer.
- o The appliance shall be stored in a room without continuously operating ignition sources (for example open flames, an operating gas appliance, or an operating electric heater).
- o Do not pierce or burn. Be aware that refrigerants may not contain an odor.
- o Refer to the unit's rating label for the maximum refrigerant charge amount.
- o Refer to your local codes and ordinances for information on handling, installation, cleaning, servicing, and disposal of refrigerant.
- o Keep any required ventilation openings clear of obstruction.
- o Service shall be performed only as recommended by the manufacturer.
- o The unit should be stored in a well-ventilated area where the room size corresponds to the room area as specified for operation;
- o The unit should be stored in a room without continuously operating open flames (for example an operating gas appliance) and ignition sources (for example an operating electric heater).



READ ALL INSTRUCTIONS BEFORE USE

ELECTRICAL SAFETY

INTEGRATED CIRCUIT BREAKER

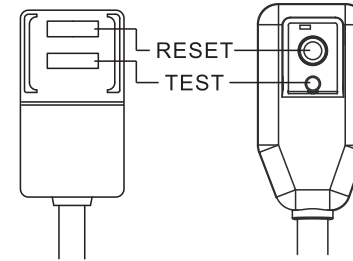

For additional safety, the power cord features an integrated circuit breaker. Test and reset buttons are provided on the plug case.

The circuit breaker should be tested periodically by pressing the TEST button. If it does not cause the circuit breaker to trip, or if the RESET button will not stay engaged, unplug the air conditioner immediately and contact your service technician.

Note: Your unit's power cord and plug may differ from the above diagram.

PREFERRED GROUNDING METHOD

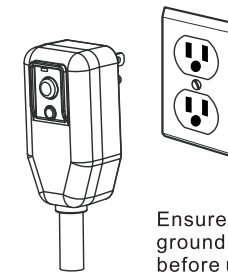

Ensure proper ground exists before use.

TEMPORARY GROUNDING METHOD

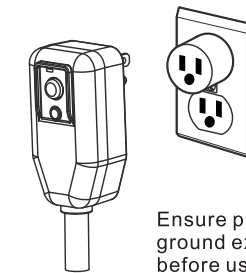

Ensure proper ground exists before use.

(Use of adapter plugs is not permitted in Canada)

Due to potential safety hazards, the use of an adapter plug is strongly discouraged.

To prevent damage to the adapter's ground terminal, hold the adapter in place while plugging in or unplugging the air conditioner.

Attaching the adapter ground terminal to the wall receptacle cover screw does not ground the appliance unless the cover screw is metal and not insulated, and the wall receptacle is grounded through the house wiring.

Frequent connection and disconnection can damage the ground terminal on the adapter. Never use a broken or damaged adapter.

SAVE THESE INSTRUCTIONS

This product is factory equipped with a power supply cord that has a three-pronged grounded plug. It must be plugged into a grounding-type receptacle in accordance with the National Electrical Code and applicable local codes and ordinances. If the circuit does not have a grounding-type receptacle, it is the responsibility and obligation of the customer to exchange the existing receptacle in accordance with the National Electrical Code and applicable local codes and ordinances. The third ground prong should not, under any circumstances, be cut or removed. Never use the cord, the plug, or the appliance when they show any sign of damage. Do not use your appliance with an extension cord unless it has been checked and tested by a qualified electrical supplier. Improper connection of the grounding plug can result in the risk of fire, electric shock, and/or injury to persons associated with the appliance. Check with a qualified service representative there is doubt that the appliance is properly grounded.

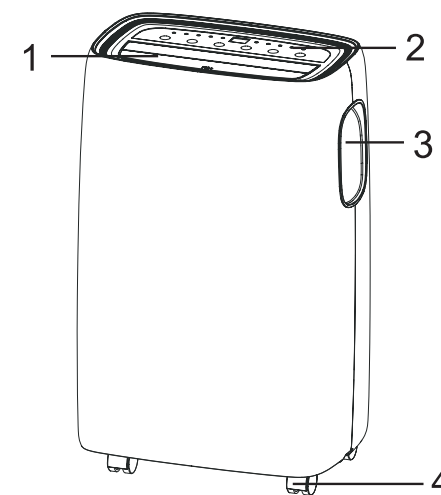

1. Air outlet grill
2. Control panel
3. Handle (both sides)
4. Castors
5. Power cord
6. Air filter
7. Air exhaust
8. Intake grill
9. Condenser drain
10. Middle drainage

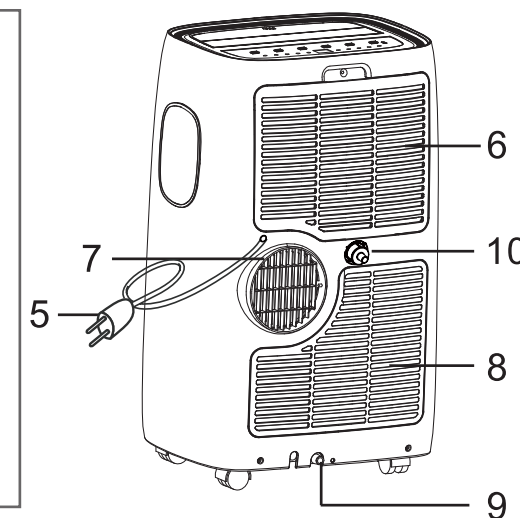

ELECTRICAL CONNECTIONS

Before plugging the appliance into the main socket, check that:

- The main power supply corresponds to the value indicated on the rating label on the back of the appliance.
- The power socket and electrical circuit are adequate for the appliance.
- The main socket matches the plug. If this is not the case, have the plug replaced.
- The main socket is adequately grounded. Failure to follow these important safety instructions absolves the manufacturer of all liability.

ACCESSORIES

PARTS	PARTS NAME	QUANTITY
	Exhaust hose Hose outlet Hose inlet	1 set
	Window slider kit	1 set
	Remote Control Batteries (Two AAA 1.5V)	1 set
	Window Sealing Sponge Assembly	1 set
	Drain Hose	1 PC

NOTE: All the illustrations in this manual are for explanatory purposes only. Your appliance may be slightly different. Be sure all accessories are removed from the packing before use.

EXHAUSTING HOT AIR

In the Cool Mode the appliance must be placed close to a window or opening so that the warm exhaust air can be ducted outside.

First position unit on a flat floor and make sure there's a minimum of 17.7" (45cm) clearance around the unit, and is within the vicinity of a single circuit outlet power source.

1. Extend either side of the hose (Fig.1)
2. Screw the hose inlet (Fig.2).
3. Screw it to the hose inlet (Fig.3).
4. Install the hose inlet into the unit (Fig.4).
5. Affix the hose outlet into the window slider kit and seal. (Fig.5 & 6).

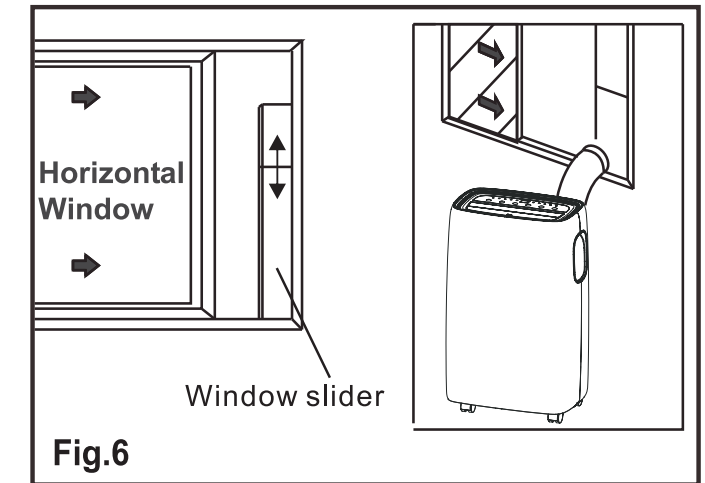
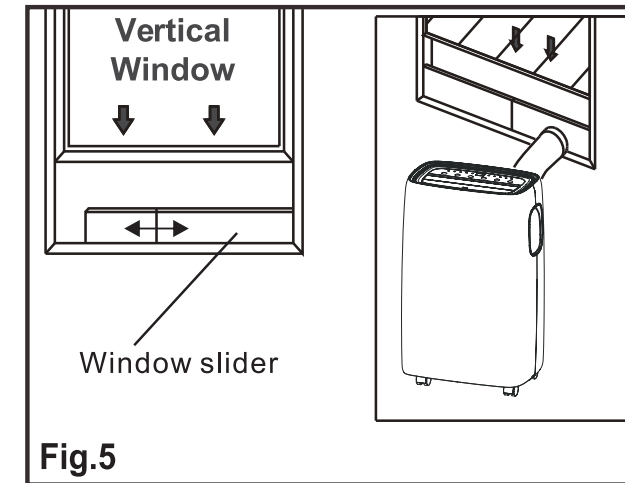
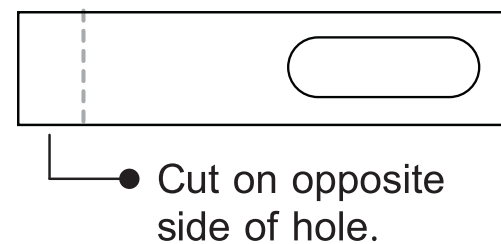
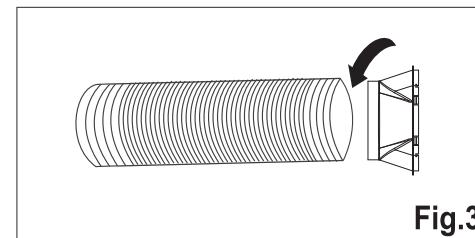
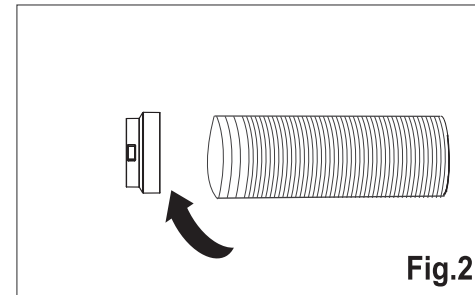
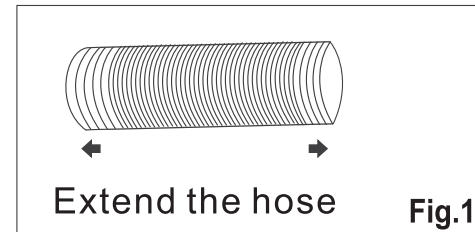
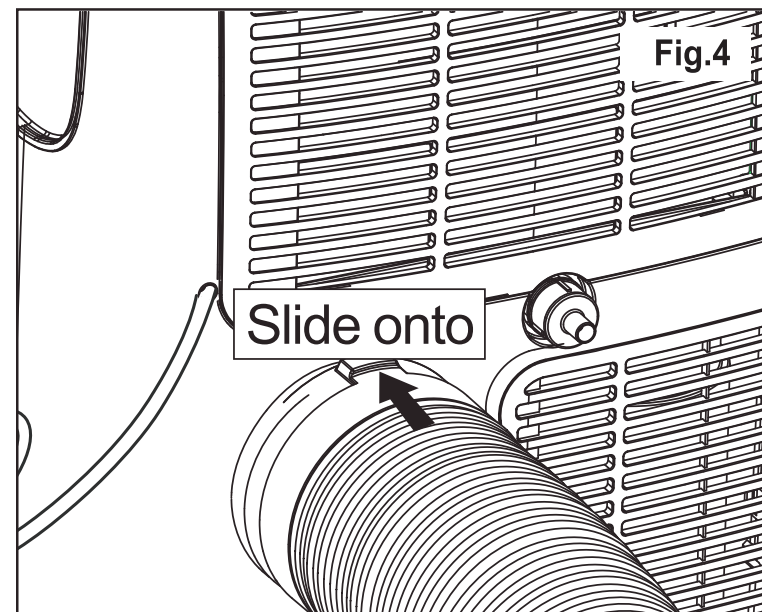

WINDOW SLIDER KIT INSTALLATION

1. Parts:
 - A) Panel
 - B) Panel with one hole
 - C) Screw to lock window kit in place
2. Assembly:

Slide Panel B into Panel A and size to window width. Window sizes vary. When sizing the window width, be sure that the window kit assembly is free from gaps and/or air pockets when taking measurements.
3. Lock the screw into the holes that correspond with the width that your window requires to ensure that there are no gaps or air pockets in the window kit assembly after installation.
4. Use the provided foam window kit sealer to close any gaps or air pockets.

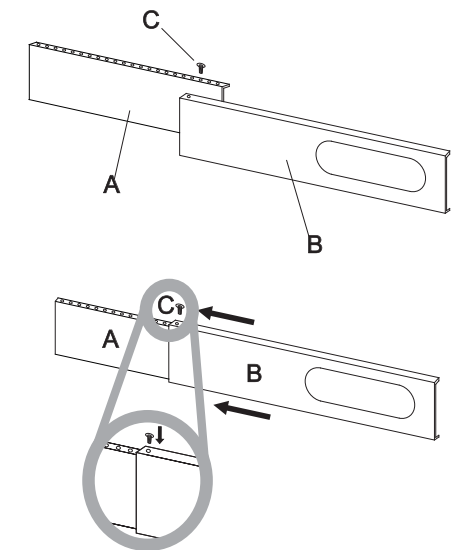

The window slider kit has been designed to fit most standard vertical and horizontal window applications, however, it may be necessary for you to modify some aspects of the installation procedures for certain types of windows. The window slider kit can be fastened with screws.

NOTE: If the window opening is less than the minimum length of the window slider kit, cut the end without the hole to fit in the window opening. Never cut the panel with the hole in your window slider kit.

1. Cut the foam seal (adhesive type) to the proper length and attach it to the window sash.
2. Attach the window slider kit to the window sash. Adjust the length of the window slider kit according to the width of window. If necessary, mark the kit and cut one end down to properly fit the window.
3. Cut the foam seal (adhesive type) to the proper length and attach it on the top of the window.
4. Close the window securely against the window slider kit.
5. Secure the window slider kit to the window sash.
6. Cut the foam seal to an appropriate length and seal the open gap between the top window frame and outer window frame.

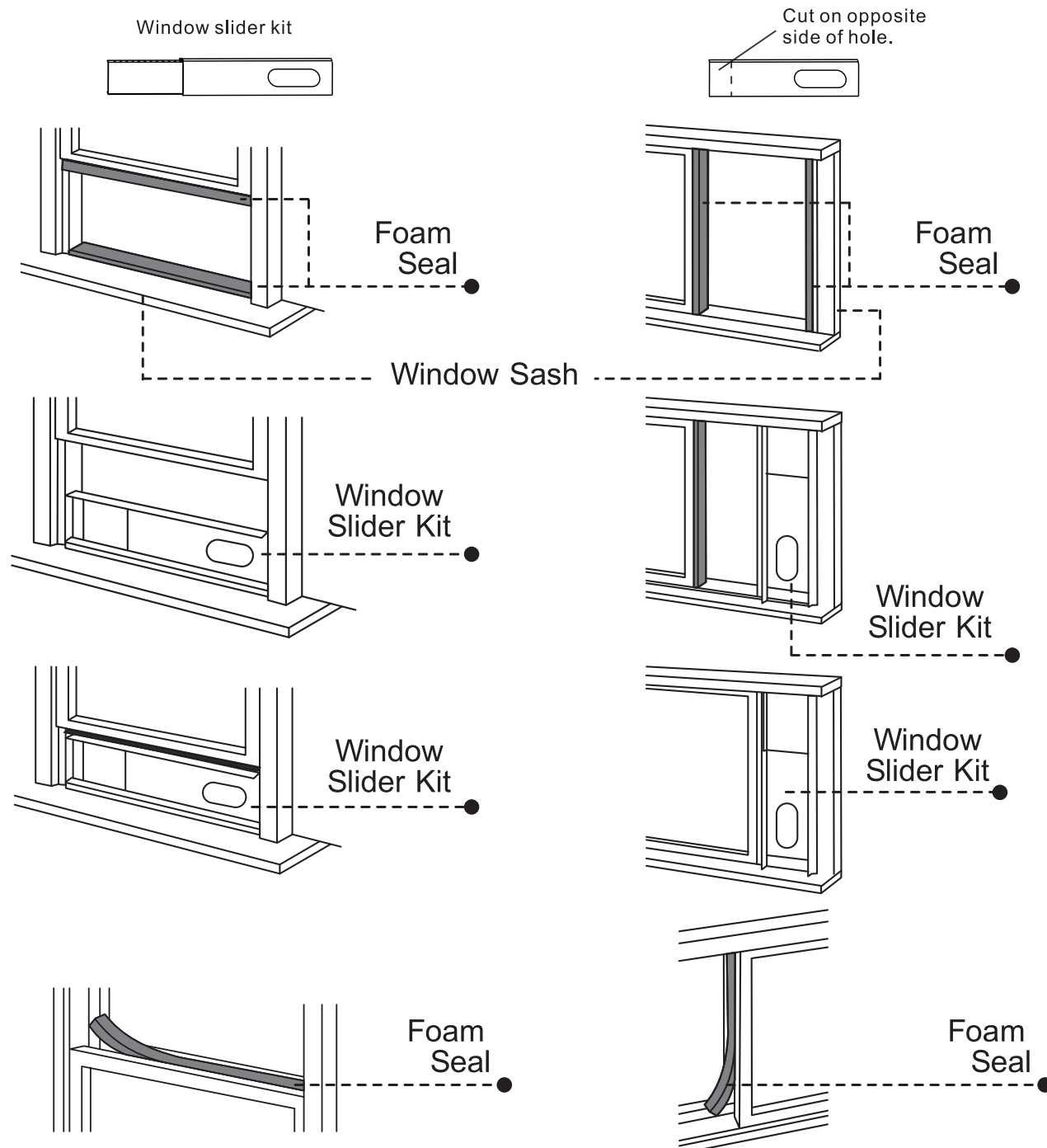

LOCATION

- The unit should be placed on a firm foundation to minimize noise and vibration. For safe and secure positioning, place the unit on a smooth, level floor strong enough to support the unit.
- The unit has casters to aid placement, but it should only be rolled on smooth, flat surfaces. Use caution when rolling on carpeted surfaces. Use caution and protect floors when rolling over wood floors. Do not attempt to roll the unit over objects.
- The unit must be placed within reach of a properly rated grounded socket.
- Never place any obstacles around the air inlet or outlet of the unit.
- Allow at least 17.5" (45cm) of space away from the wall for efficient air conditioning.
- The hose can be extended, but it is the best to keep the length to a minimum of 15.7" (40cm). Make sure that the hose does not have any sharp bends or sags.

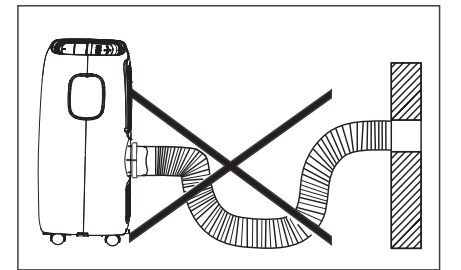
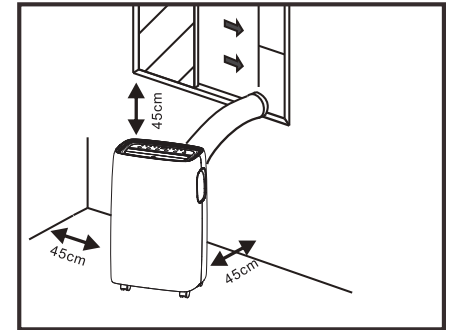

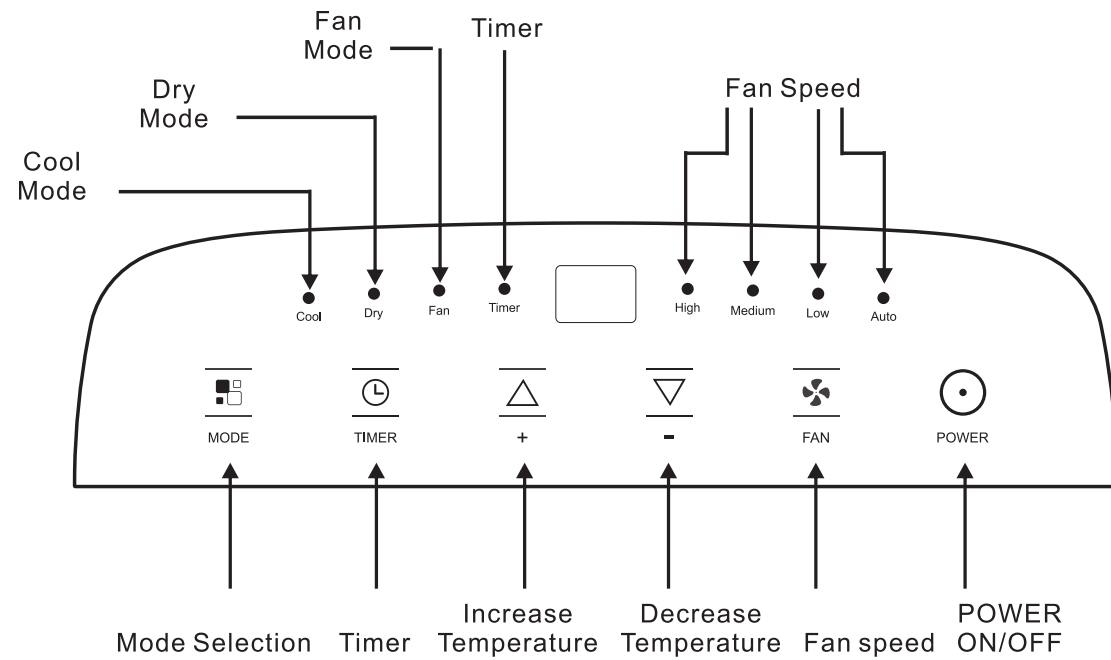

TURNING THE APPLIANCE ON

Plug the air conditioner into an electrical outlet.

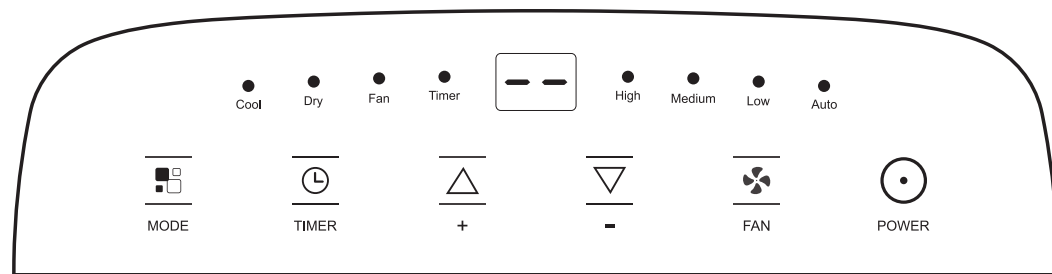





Press the “” button to make the appliance turn on. The last function active when it was turned off will appear.

✓ Never turn the air conditioner off by unplugging from the outlet. Always press the power button , then wait for a few minutes before unplugging. This allows the appliance to perform a cycle of checks to verify operation.

COOL mode

Ideal for hot, muggy weather when you need to cool and dehumidify the room. To set this mode correctly:

- Press the “” button a number of times until the “Cool” symbol appears.
- Select the desired temperature 64°F-90°F(18°C-32°C) by pressing the “” or “” button until the corresponding value is displayed.
- Select the desired fan speed by pressing the “” button. Four speed settings are available: High / Medium / Low / Auto.

The most suitable temperature for the room during the summer varies from 70 °F to 76°F (21°C to 24°C). The fan speed difference is more noticeable when the appliance is under Fan mode but may not be noticeable under Cool mode.



- This unit features a self-evaporating system, and under normal operating conditions should not require having the tank emptied.
- Under prolonged/high humidity conditions, you may be required to empty the tank.
- When the tank is full, the appliance shuts down and “**Fl**” (full tank) appears on the display. The tank cap must be removed and emptied. Let all of the water in basin drain out. When all of the water has been drained, the air conditioner will start up again.



NOTE:

- **When operating in very cold rooms, the appliance will defrost automatically, interrupting normal operation. “**LE**” appears on the display. During this operation, it is normal for the air conditioner to make noises as it's defrosting.**
- **In this mode, the fan may operate for short periods even though the set temperature has already been reached.**

FAN mode

When using the appliance in this mode, the air hose does not need to be attached.

- Press the “” button until the “Fan” symbol illuminates.
- Select the required fan speed by pressing the “” button. Three speeds are available: High / Medium / Low.

The screen will display “” for high speed, “” for medium speed, “” for low speed.

◆ DRY mode (dehumidifier only mode)

Ideal to reduce room humidity without cooling (spring and autumn, damp rooms, rainy periods, etc). In dry mode, the appliance should be installed in the same way as the cool mode with the air exhaust hose attached to enable moist/humid air to be vented outside.

To set this mode correctly:



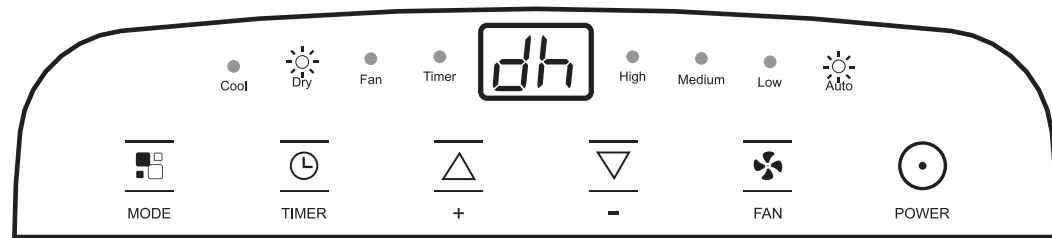

- Press the “” button until the Dry symbol illuminates. The screen will display “dh”.
- In this mode, fan speed is selected automatically by the appliance and can not be set manually.







🕒 SETTING THE TIMER

- This timer can be used to delay the appliance startup or shutdown. This avoids wasting electricity by optimizing the unit's operation.

Programming start up



- Turn on the appliance and choose the mode you want.
For example: Cool; 75°F; High fan speed. Turn off the appliance.
- Press the “” button and the screen will display 1-24 hours.
- Press “” several times until the desired time is displayed.
Wait 5 seconds and the “Timer” symbol will be displayed on the screen.
- Press the “” button again or the “” button, and the timer will be canceled.

Timer programming shut down

- When the appliance is running, press the “” button, the screen will display hours.
- Press “” several times until desired time is displayed. After about 5 seconds, the timer will be active and the “Timer” symbol will be displayed on the screen.
- Press the “” button again or the “” button, and the timer will be canceled.

SELF-DIAGNOSIS

The appliance has a self diagnosis system to identify unit malfunctions. Error messages are displayed on the appliance display.

IF DISPLAYED	WHAT SHOULD I DO?
 <p>LOW TEMPERATURE (frost prevention)</p>	<p>The appliance is fitted with a frost protection device to avoid excessive formation of ice.</p> <p>The appliance starts up again automatically when the defrosting process is completed.</p>
 <p>PROBE FAILURE (sensor damaged)</p>	<p>If this is displayed, contact your local authorize service center.</p>
 <p>FULL TANK (safety tank full)</p>	<p>Empty the internal safety tank, following the instructions in the "End of season operations" paragraph.</p>

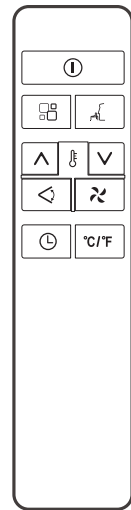

ⓘ	On/Off button	🌀	Fan speed button
^	Increase button	📺	Mode button
v	Decrease button	◀	Swing button
🕒	Timer button	🛏	Sleep button
°C/°F	Unit Switch button		

- ✓ Point the remote control at the sensor on the appliance.
- ✓ The remote control must be no more than 23ft away from the appliance without obstacles between the remote control and the receiver.
- ✓ The remote control must be handled with extreme care. Do not drop it or expose it to direct sunlight or sources of heat. If the remote control does not work, check the batteries and replace with new batteries. Do not mix new and old batteries.

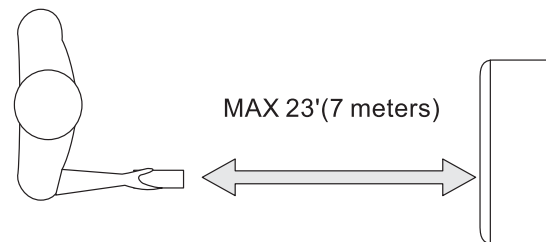

INSERTING OR REPLACING THE BATTERIES

- Remove the cover on the rear of the remote control;
- Insert two "AAA" 1.5V batteries in the correct position (see instructions inside the battery compartment);



NOTE:

- ✓ If the remote control unit is replaced or disposed of the batteries must be removed and discarded in accordance with current legislation, as they are harmful to the environment.
- ✓ Do not mix old and new batteries. Do not mix alkaline, standard (carbon-zinc) or rechargeable (nickel-cadmium) batteries.
- ✓ Batteries may explode or leak if exposed to open flames. Dispose of batteries accordingly.
- ✓ If the remote control is not being used for extended periods of time (winter storage), remove the batteries and store in a cool, dry location.

COOL mode



Ideal for hot, muggy weather when you need to cool and dehumidify the room. To set this mode correctly:

- Press the “📺” button a number of times until the “Cool” symbol appears.
- Select the target temperature 64°F-90°F (18°C-32°C) by pressing the “^” or “v” button until the corresponding value is displayed.
- Select the required fan speed by pressing the “🌀” button. Four speed settings are available: High/Med/Low/Auto.

The most suitable temperature for the room during the summer varies from 70°F to 76°F (21°C to 24°C). The fan speed difference is more noticeable when the appliance is under FAN mode but may not be noticeable under COOL mode.

FAN mode



When using the appliance in this mode, the air hose does not need to be attached.

- Press the “” button until the “Fan” symbol appears on the unit panel .
- Select the required fan speed by pressing the “” button.
Three speed settings are available: High/Med/Low.

DRY mode

Ideal to reduce room humidity (spring and autumn, damp rooms, rainy periods, etc.). In dry mode, the appliance should be installed in the same way as the cool mode, with the air exhaust hose attached to enable moist/humid air to be vented outside.

To set this mode Fan correctly:

- Press the “” button a number of times until the “” symbol appears on the unit panel.
- In this mode, fan speed is selected automatically by the appliance and can not be set manually.

SMART mode

The appliance chooses automatically whether to operate in cool, fan or heat mode (certain models have heat mode) .

- Press the “” button a number of times until the screen of the unit display below:

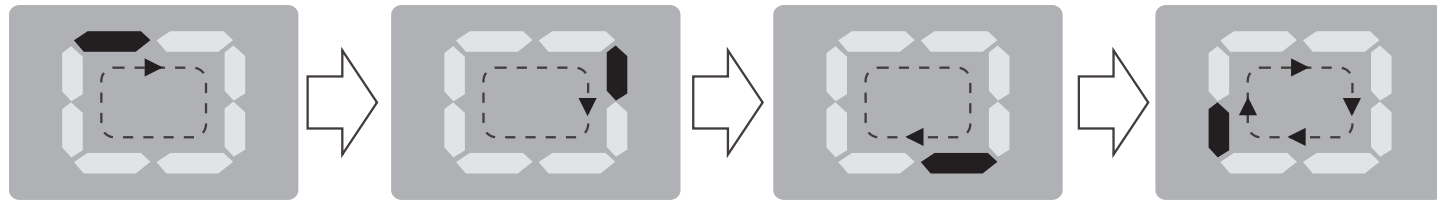

When the unit is in SMART mode the display will show a circulating dash.

- Select the required fan speed by pressing the “” button.
Four speed settings are available: High / Medium / Low / Auto.

If the appliance is a cooling-only model, the unit operates in Fan mode when the room temperature is below 73°F (23°C) and in Cool mode when the room temperatures is above 73°F (23°C).

If the unit is a heat-cool model, the unit operates in Heat mode when the room temperature is 68°F (20°C). and in Fan mode when the room temperature is from 68°F (20°C) to 73°F (23°C), and in Cool mode when the room temperature is above 73°F (23°C).

SWING function

This function is useful for select the up/down swing of air delivery.

To set this function correctly:

- Select the operating mode (Cool, Dry, Fan) as described above.
- Press the “” button and the deflector will stop at different positions or it will swing continuously.

SLEEP function

This function is useful at night as it gradually reduces operation of the appliance.

To set this function correctly:

- Select the cool or heat mode as described above.
- Press the “” button.

When you choose the sleep function, the screen's brightness will be reduced, and the fan speed will run on low.

The SLEEP function maintains the room at optimum temperature without excessive fluctuations in either temperature or humidity with silent operation. Fan speed is always at Low, while room temperature and humidity vary gradually to ensure the room remains comfortable.

When in COOL mode, the selected temperature will increase by 1°F (1°C) per hour in a 2 hour period. This new temperature will be maintained for the next 6 hours. Then the appliance will turn off.

When in HEAT mode, the selected temperature will decrease by 1°F (1°C) per hour in a 3 hour period. This new temperature will be maintained for the next 5 hours. Then the appliance will turn off.

The SLEEP function can be canceled at any time during operation by pressing the "Sleep", "Mode" or "Fan speed" button. In FAN or DRY mode, the SLEEP function cannot be set.





Switch from Celsius to Fahrenheit

When the appliance is in standby, press the “” button to change the unit of temperature.





SETTING THE TIMER

This timer can be used to delay the appliance startup or shutdown. This avoids wasting electricity by optimizing operating periods.

Programming start up

- Turn on the appliance and choose the mode you want.
For example: Cool; 75°F; High fan speed. Turn off the appliance.
- Press the “” button and the screen will display 1-24 hours.
- Press “” several times until the desired time is displayed. After about 5 seconds, the timer will be active and the “Timer” symbol will be displayed on the screen.
- Press the “” button again or the “” button, and the timer will be canceled.

Programming shut down

- When the appliance is running, press the “” button, the screen will display hours.
- Press “” several times until desired time is displayed. After about 5 seconds, the timer will be active and the “Timer” symbol will be displayed on the screen.
- Press the “” button again or the “” button, and the timer will be canceled.

To get the optimal performance from your appliance, follow these recommendations:

- Close the windows and doors in the room to be air conditioned (Fig. 21). When installing the appliance semi-permanently, you should leave a door slightly open (as little as 1 cm) to guarantee correct ventilation.
- Protect the room from direct exposure to the sun by partially closing curtains and/or blinds to make the appliance much more economical to run (Fig. 22).
- Never rest objects of any kind on the appliance.
- Do not obstruct the air intake and outlet (Fig. 23). Leave the grilles free.
- Make sure there are no heat sources in the room.
- Never use the appliance in very damp rooms (laundry room, for example).
- Never use the appliance outdoors.
- Make sure the appliance is standing on a level surface.

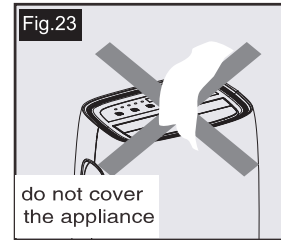
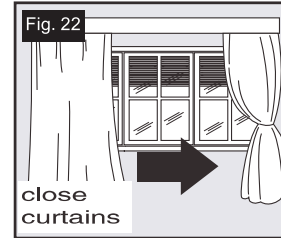
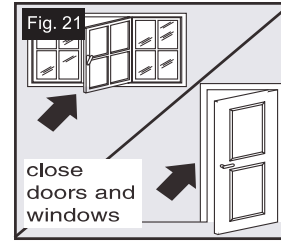

When there is excess water condensation inside the unit, the appliance stops running and shows “F L” (FULL TANK as mentioned in SELF-DIAGNOSE). This indicates that the water condensation needs to be drained using the following procedures:

Manual Draining (Fig.24)

1. Unplug the unit from power source.
2. Place a pan (not provided) under the lower drain plug. See diagram.
3. Remove the lower drain plug.
4. Water will drain out and collect in the pan.
5. After the water is drained, replace the lower drain plug firmly.
6. Turn on the unit.

Continuous Draining (Fig.25)

1. Unplug the unit from the power source.
2. Remove the drain plug. While doing this operation some residual water may spill so please have a pan (not provided) to collect the water.
3. Unscrew the drain cap of continuous drain outlet.
4. Connect one end of the garden hose (sold separately) or drainage hose (not supplied) to the drain outlet then lead the other end into a drain or bucket that is lower than the unit.
5. Turn on the unit.

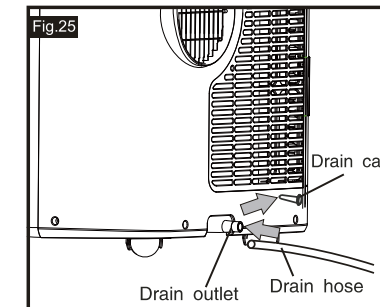
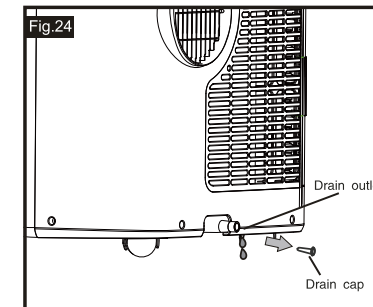

NOTE:

Please be sure that the height of and section of the drain hose should not be higher than that of the drain outlet, or the water tank may not drain. (Fig.26 and Fig.27)

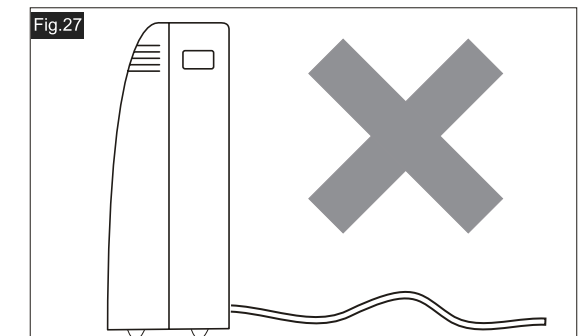
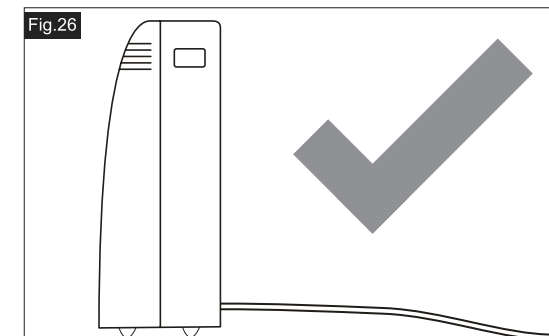

Middle drainage

When the unit is running in Dry mode, you can choose the way below for drainage.

1. Unplug the unit from the power source.
2. Remove the drain plug (Fig.A). While doing this operation some residual water may spill so please have a pan to collect the water.
3. Connect the drain hose (1/2" or 12.7mm, maybe not supplied). (Fig.B)
4. The water can be continuously drained through the hose into a floor drain or bucket.
5. Turn on the unit.

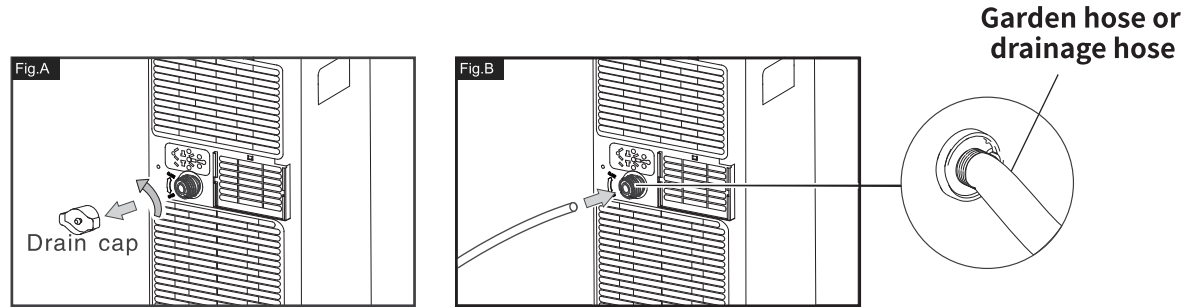

NOTE:

- Condensation may flow out after removing the drain cap, if the unit is running in Cool and Dry mode. When you want to remove the garden hose, prepare a drip tray (not supplied) to collect the condensate from the drain outlet.
- Please be sure that the height of the drain and section of the drain hose should not be higher than that of the drain outlet, or the continuous drainage may not work properly (Fig.C & Fig.D).
- During Cool mode, it is recommended to disable continuous drainage by replacing the drain cap to the drain outlet, to reach the maximum performance.

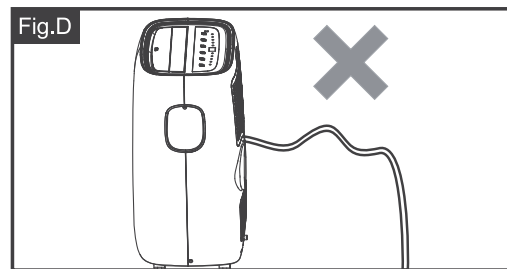
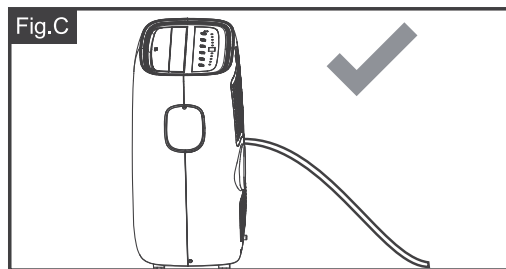

Before cleaning or maintenance, turn the appliance off by pressing the  button on the control panel or remote control, wait for a few minutes then unplug from the mains socket.

CLEANING THE CABINET

You should clean the appliance with a slightly damp cloth then dry with a dry cloth, do not use water to wash appliance.

- Never submerge the appliance in water. It could be dangerous.
- Never use gasoline, alcohol or solvents to clean the appliance.
- Never spray insecticide liquids or similar.

CLEANING THE AIR FILTERS

To keep your appliance working efficiently, you should clean the filter every week of operation. Follow the Fig.28 direction and open the unit grill, then take out evaporator from the back of grill.

Use a vacuum cleaner to remove dust accumulations from the filter. If it is very dirty, immerse in warm water and rinse a number of times. The water should never be hotter than 104°F (40°C). After washing, leave the filter to dry then attach the intake grille to the appliance.

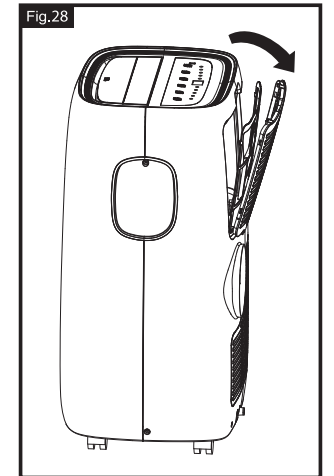

START AND END OF SEASON OPERATIONS

START OF SEASON

Make sure the power cable and plug are undamaged and the grounding system is efficient. Follow the installation instructions precisely.

END OF SEASON

To empty the internal circuit completely of water, remove the cap. Run off all water left into a basin. When all the water has been drained, (Fig.32) put the cap back in place.

Clean the filter and dry thoroughly before putting back.

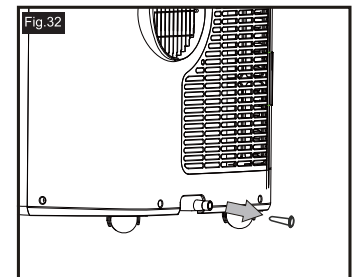

ROOM CONDITIONS

Temperature of room 64°F-95°F (18°C-35°C) (Cooling)

Temperature of room 50°F-77°F (10°C-25°C) (Heating)

PROBLEM	POSSIBLE CAUSES	SOLUTIONS
The appliance does not come on	<ul style="list-style-type: none"> There is no current It is not plugged in The internal safety device has tripped 	<ul style="list-style-type: none"> Check the power supply Plug the unit into a power outlet Wait 30 minutes. If the problem persists, contact customer service
The appliance works for a short time only	<ul style="list-style-type: none"> There are bends in the air exhaust hose Something is preventing the air from being discharged 	<ul style="list-style-type: none"> Position the air exhaust hose correctly, keeping it as short as possible and free of curves to avoid bottlenecks Check and remove any obstacles obstructing air discharge
The appliance works but does not cool the room	<ul style="list-style-type: none"> Windows, doors, and/or curtains open 	<ul style="list-style-type: none"> Close doors, windows, and curtains bearing in mind the "tips for correct use" given above
	<ul style="list-style-type: none"> There are heat sources in the room (oven, hairdryer, etc) 	<ul style="list-style-type: none"> Eliminate the heat sources
	<ul style="list-style-type: none"> The air exhaust hose is detached from the appliance 	<ul style="list-style-type: none"> Fit the air exhaust hose in the housing at the back of the appliance
	<ul style="list-style-type: none"> The technical specification of the appliance is not adequate for the room in which it is located 	<ul style="list-style-type: none"> Consider replacing the unit with a higher BTU capacity.
During operation, there is an unpleasant smell in the room	<ul style="list-style-type: none"> Air filter clogged 	<ul style="list-style-type: none"> Clean the filter as described above

PROBLEM	POSSIBLE CAUSES	SOLUTIONS
The appliance does not operate for about three minutes after restarting it	<ul style="list-style-type: none"> The internal compressor safety device prevents the appliance from being restarted until three minutes have elapsed since it was last turned off 	<ul style="list-style-type: none"> Wait. This delay is part of normal operation
The following message appears on the display: 	<ul style="list-style-type: none"> The appliance has a self-diagnosing system to identify unit malfunctions 	<ul style="list-style-type: none"> See the SELF-DIAGNOSIS section above



5401 Dansher Road
Countryside, IL 60625

855-663-9463 | www.arcticwindac.com